

DETALLE DE LA ESTRUCTURA DE LA CUBIERTA

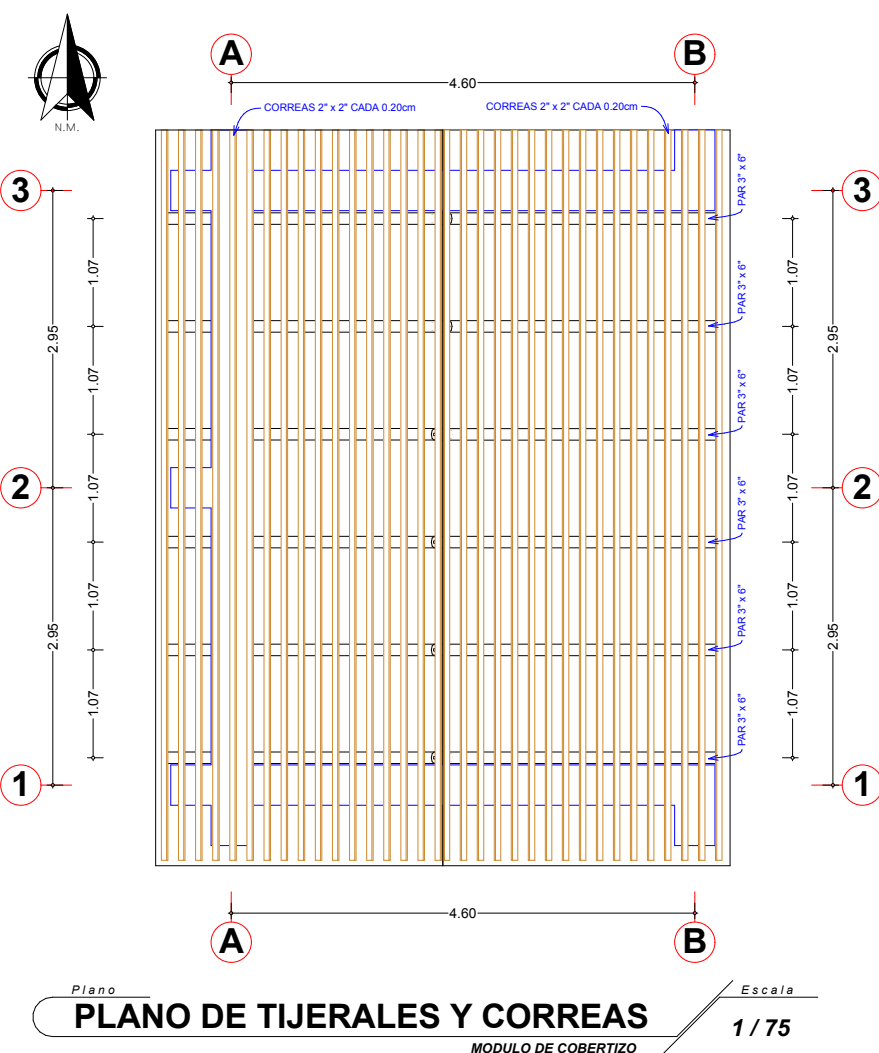

PLANO DE TECHOS
ARQUITECTURA
Escala 1/75

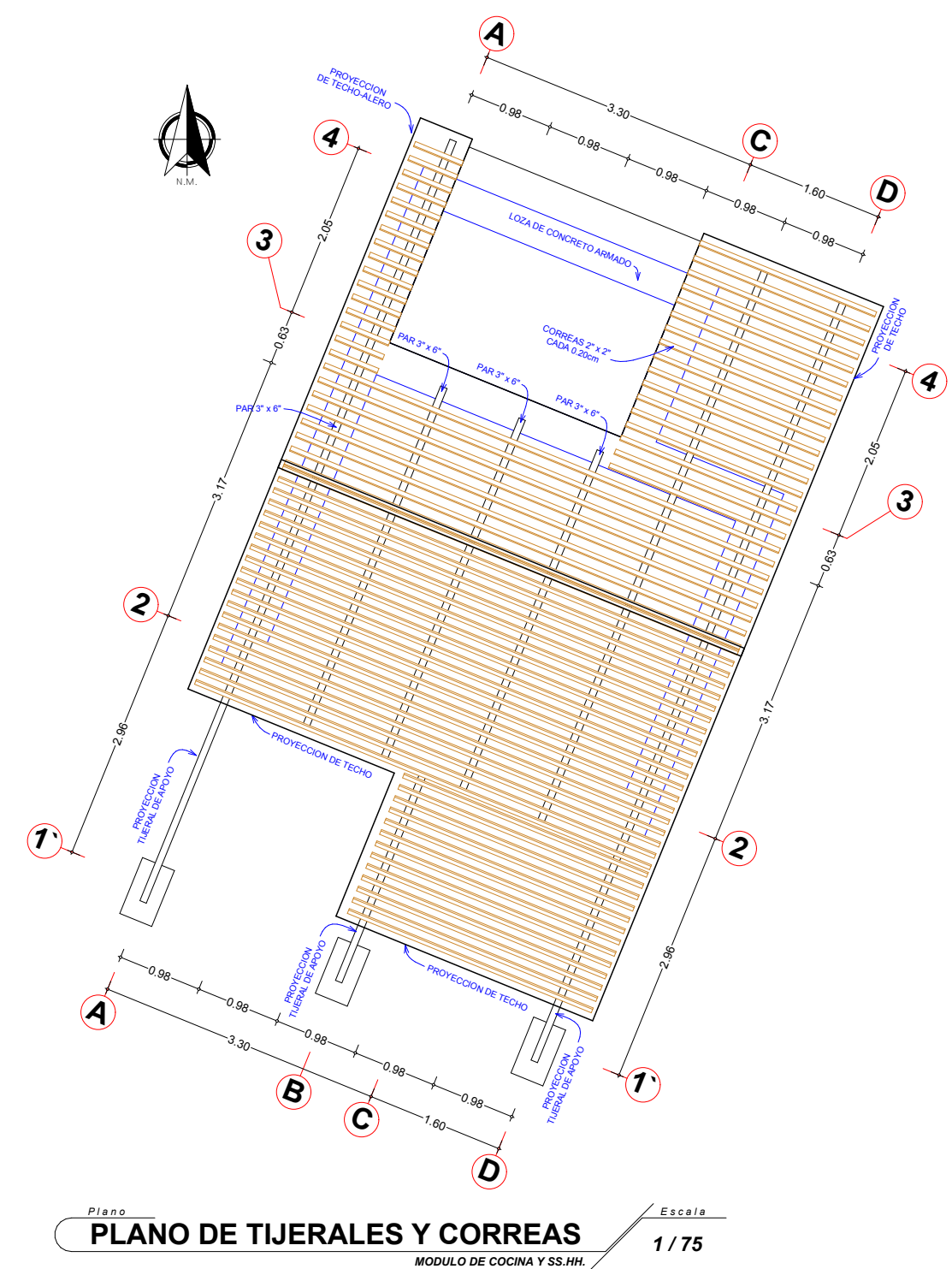
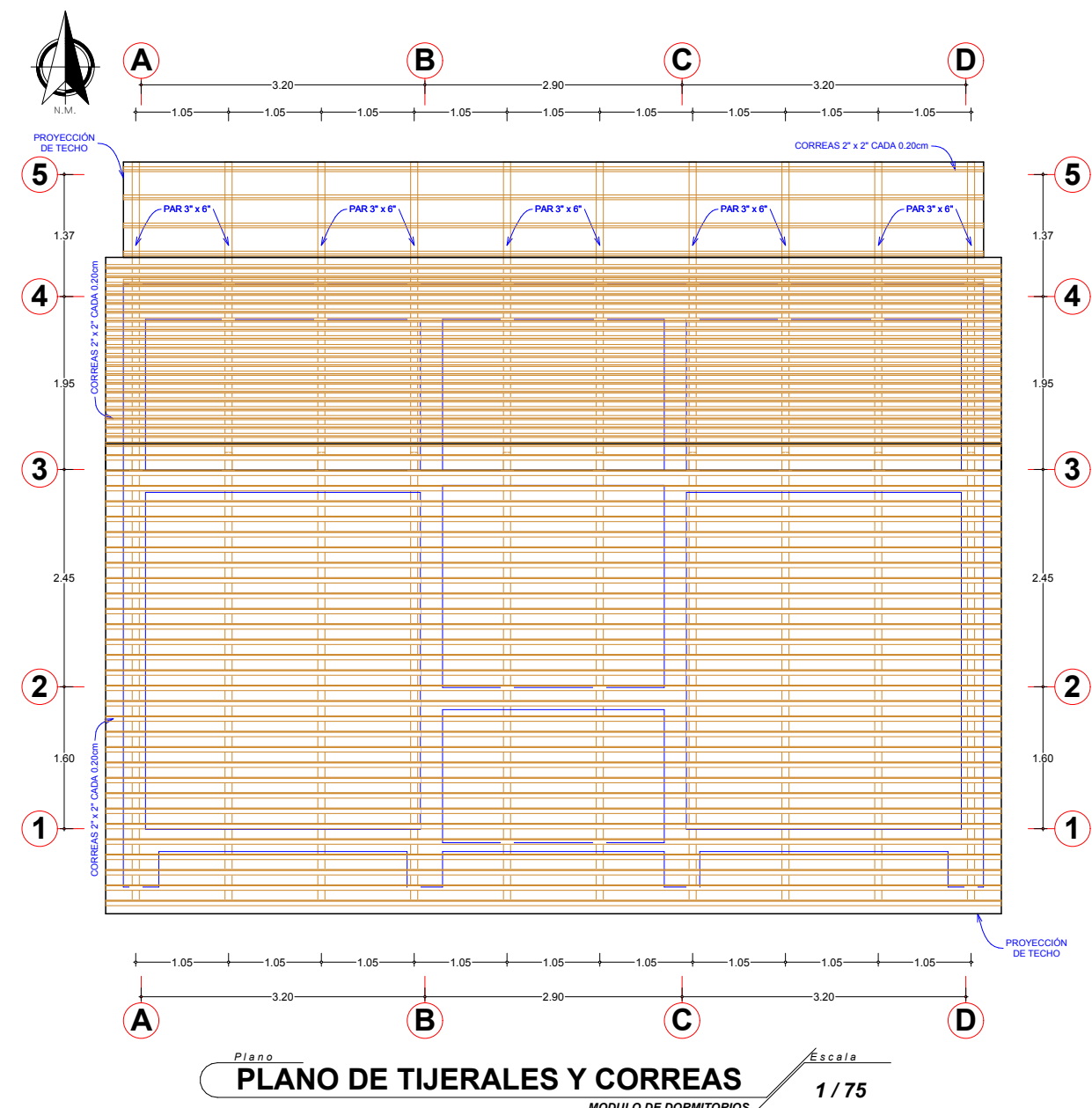
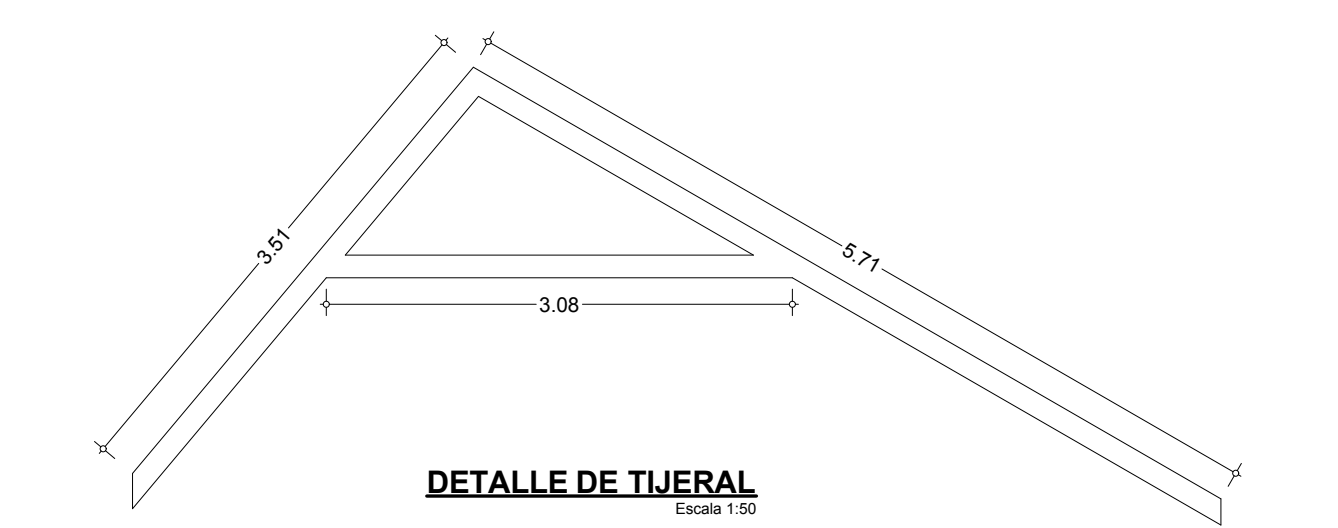
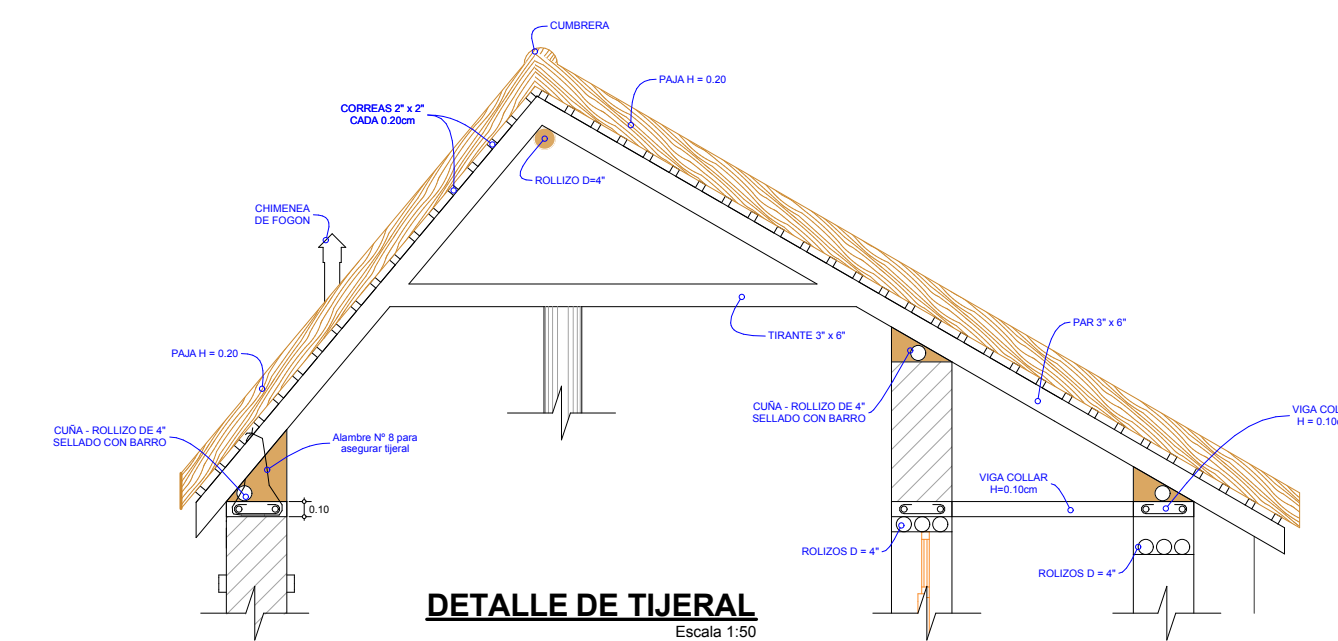
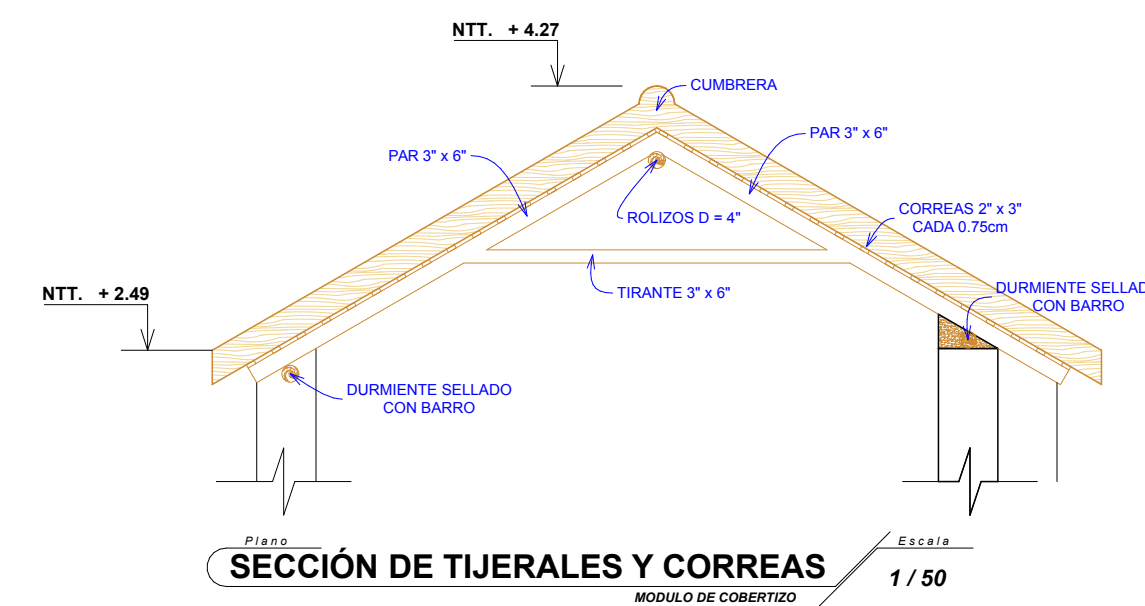
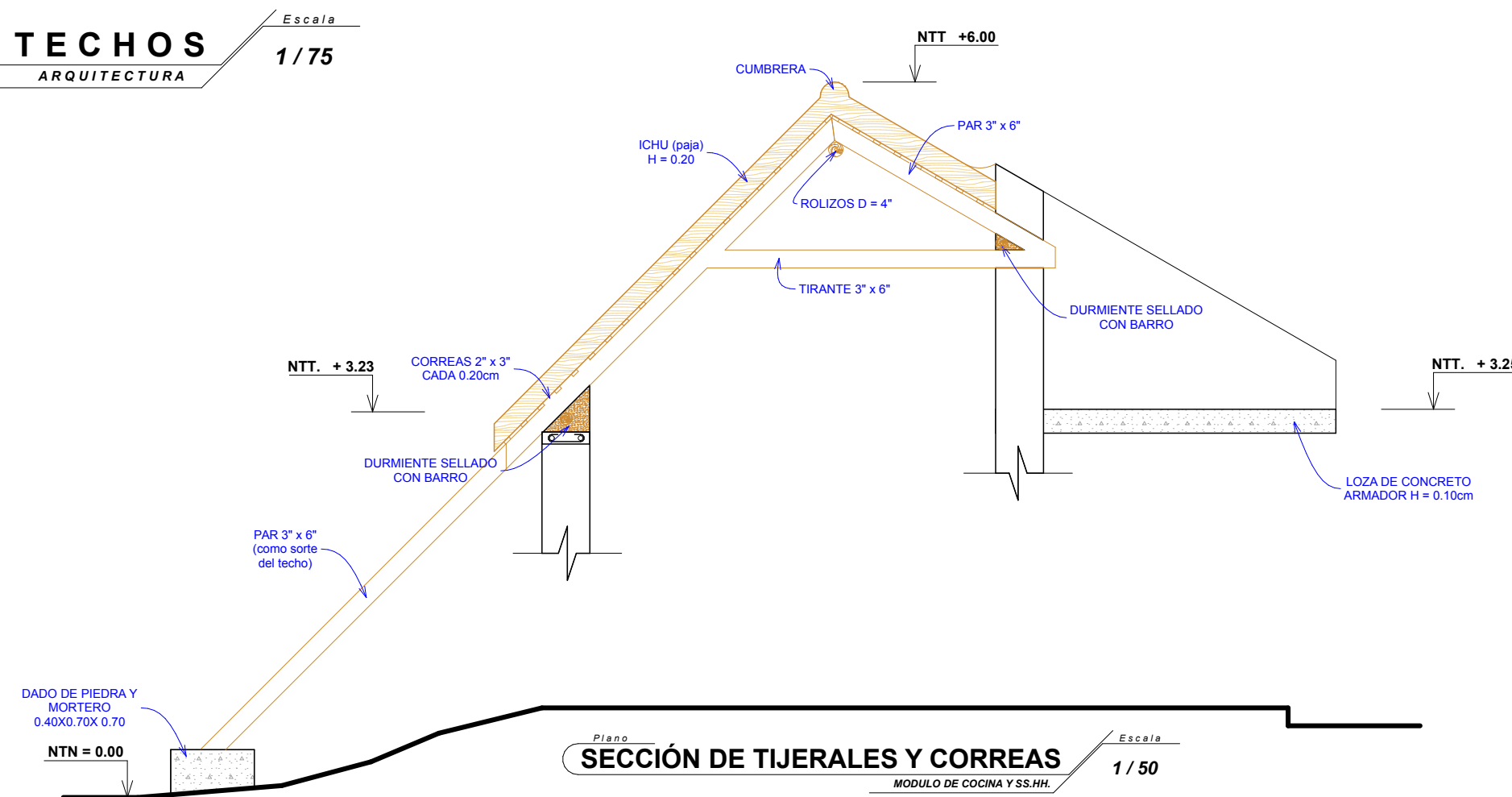
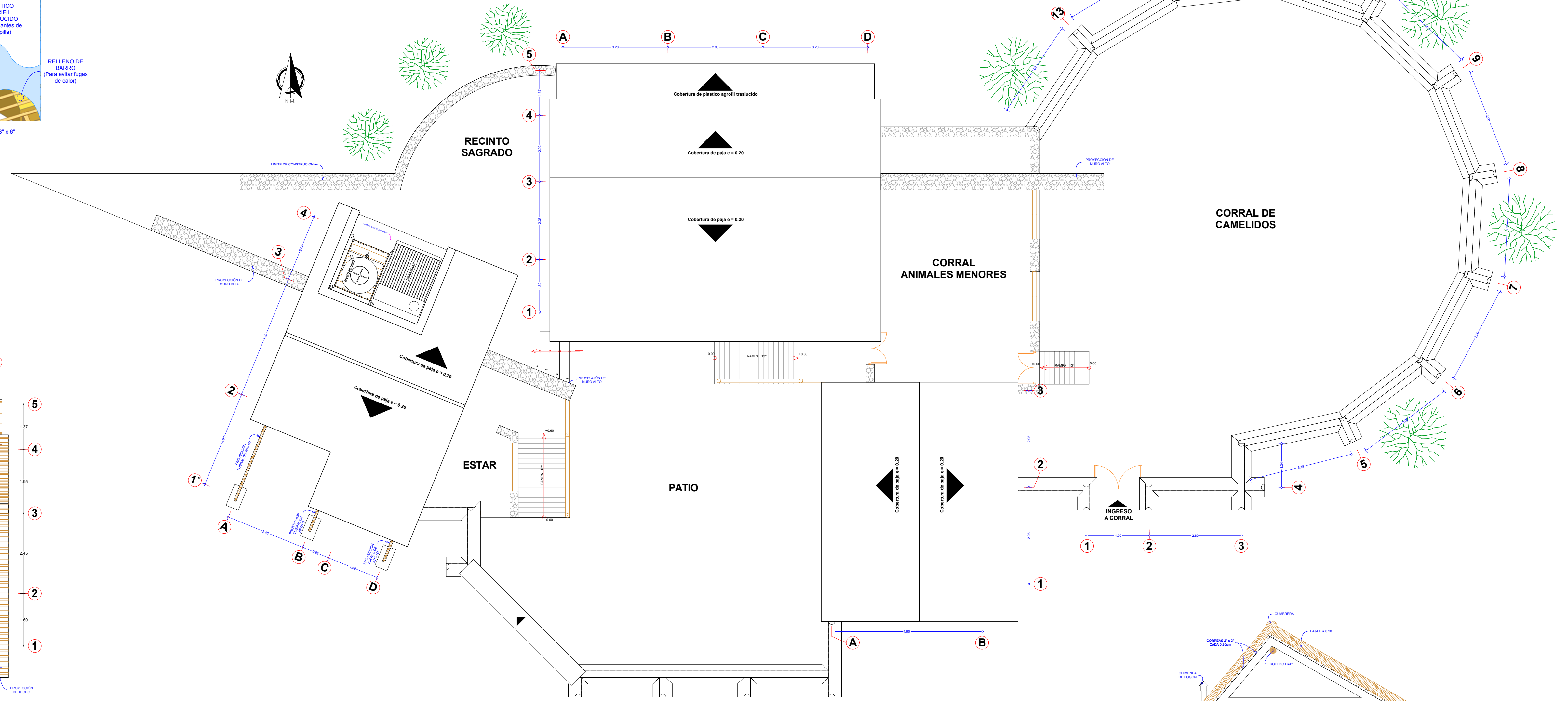

FACULTAD DE ING. CIVIL Y ARQUITECTURA UNA-PUNO ESCUELA PROFESIONAL DE ARQUITECTURA Y URBANISMO VIVIENDA RURAL SALUDABLE COMO ESTRATEGIA DE DESARROLLO EN LAS COMUNIDADES DE COLINE, CAYCO (crucero alto) Y ALTO HUANCANE DEL DISTRITO DE SANTA LUCIA	PUNO INDICADA Enero del 2016
TÍTULO: PLANO DE TECHOS (De dos Dormitorios)	A-06
AUTOR: Bach. Arq. LUIS HUMPIRI LAZARTE	LAMP A
COORDINADOR: Bach. Arq. L. H. L.	SANTA LUCIA
LOCALIDAD: COLINE, CAYCO Y ALTO HUANCANE	